

산업용 누전차단기

225AF **CGE-203N**

동작특성 곡선

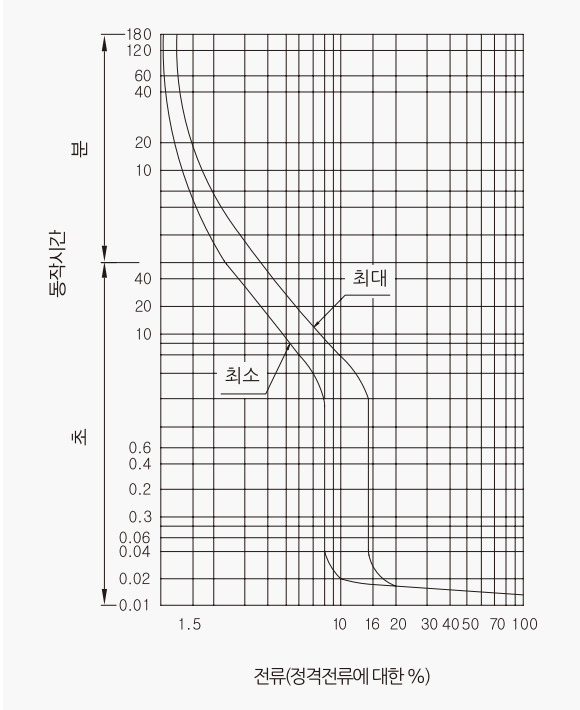

온도보정곡선

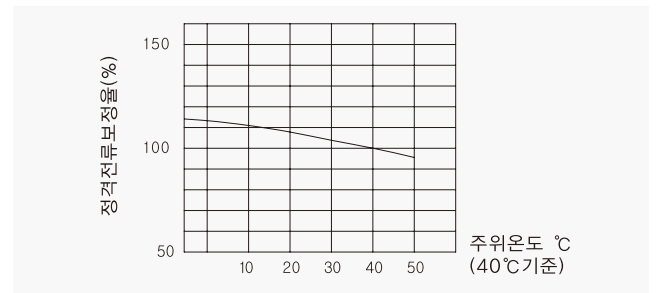

외형 치수도 Dimensions

◆ 3 POLE

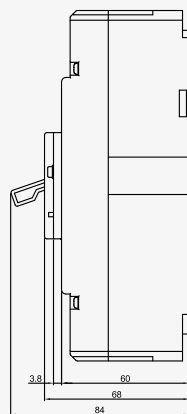
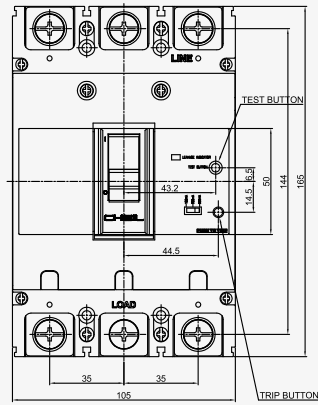

◆ 부착 HOLE

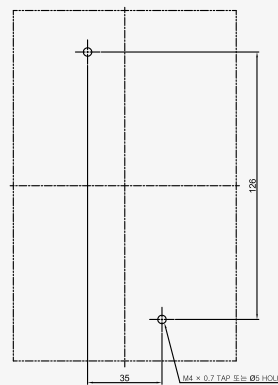

◆ PANEL CUT

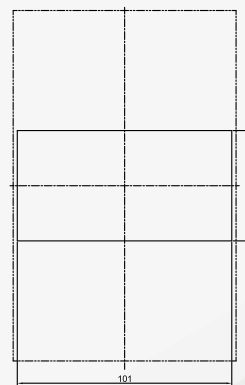

◆ 단자부 상세도

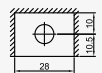

◆ 접속 도체 가공도

